

ソケット付鉄筋コンクリートU形 (たて水路型)

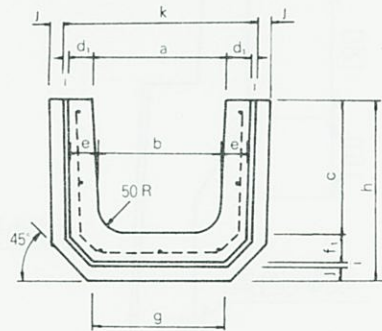

すべり止め付き

注 () 内は 300 用です。

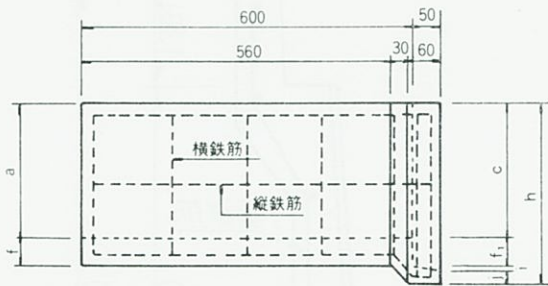
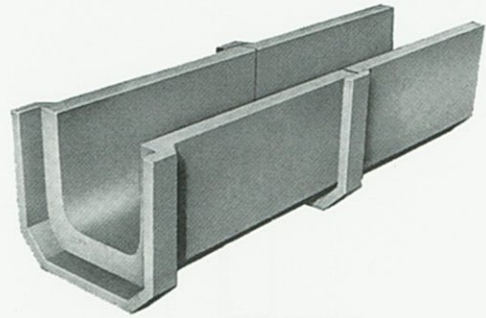
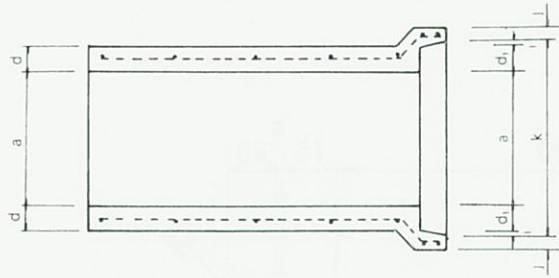
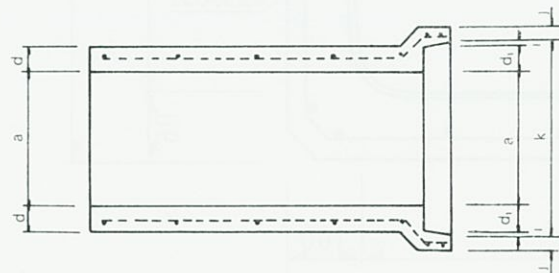

呼び名	重量 (kg)
240	63
すべり止め付き	64
300	89
すべり止め付き	90

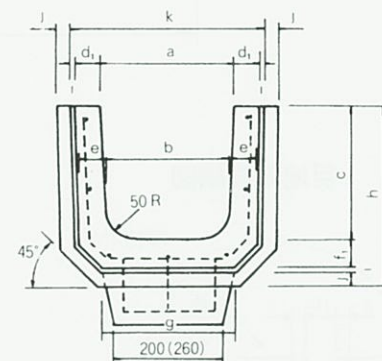
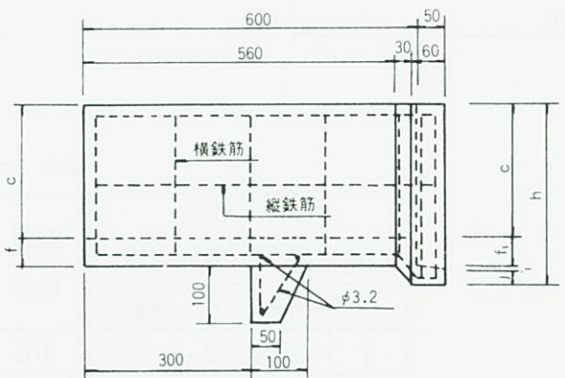

呼び名	寸 法 (mm)													鉄 筋			
	a	b	c	d	d ₁	e	f	f ₁	g	h	i	j	k	縦鉄筋		横鉄筋	
														径 (mm)	数量	径 (mm)	数量
240	240	220	240	45	47	52	50	52	240	325	8	25	350	3.2	7	3.2	7
300	300	260	300	50	52	62	60	62	300	405	13	30	430	3.2	9	4.0	7