

横浜市型接続雨水浸透ます (タイプ4)

組立図

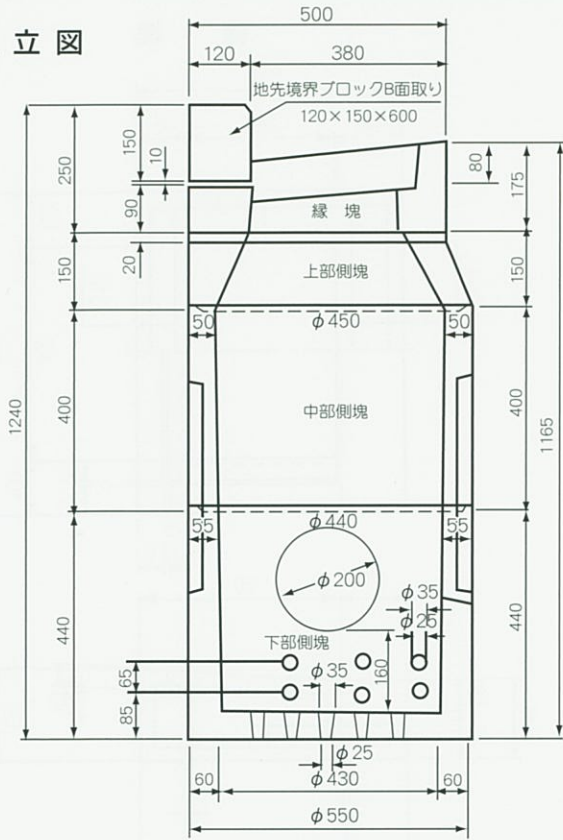

コンクリートふた

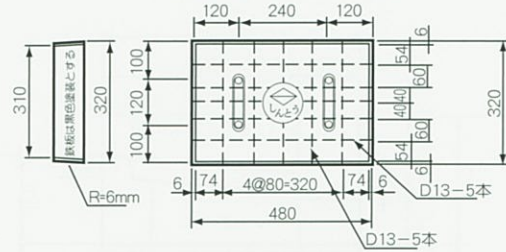

縁塊

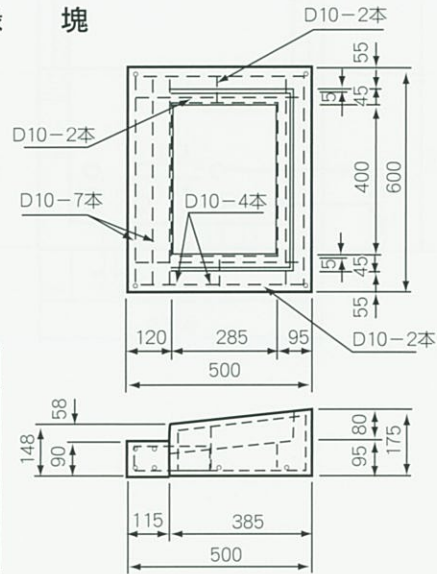

呼び名	参考重量 (kg)
ふた	30
縁塊	52
上部側塊	49
中部側塊	73
下部側塊	109

上部側塊

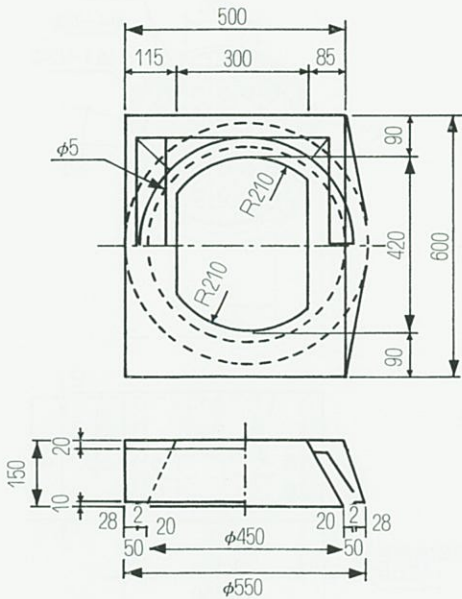

中部側塊

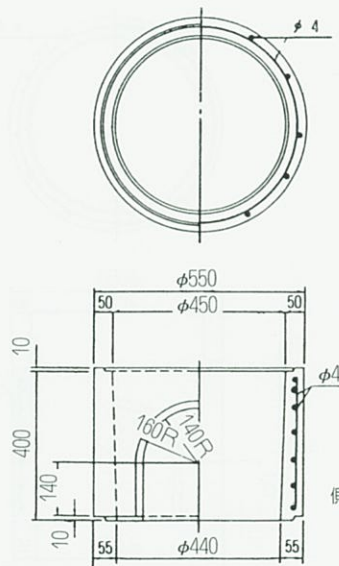

下部側塊

