

横浜市型雨水浸透ます (タイプ1)

組立図

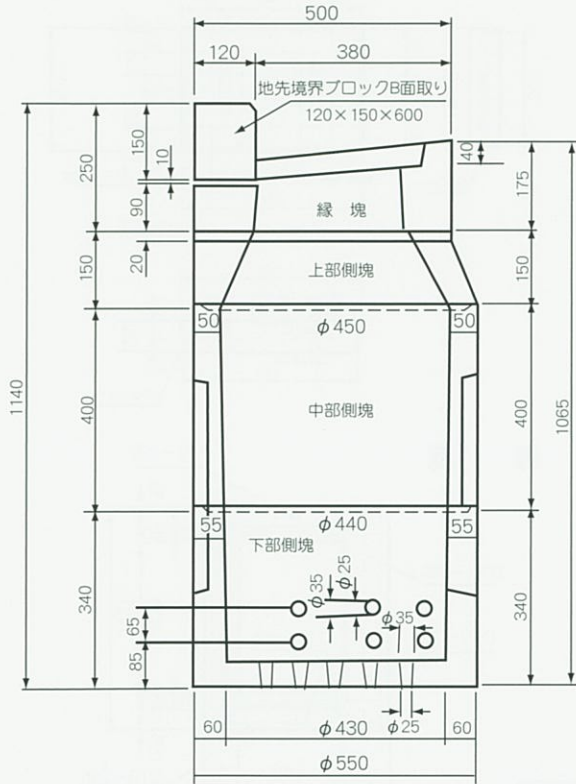

縁塊

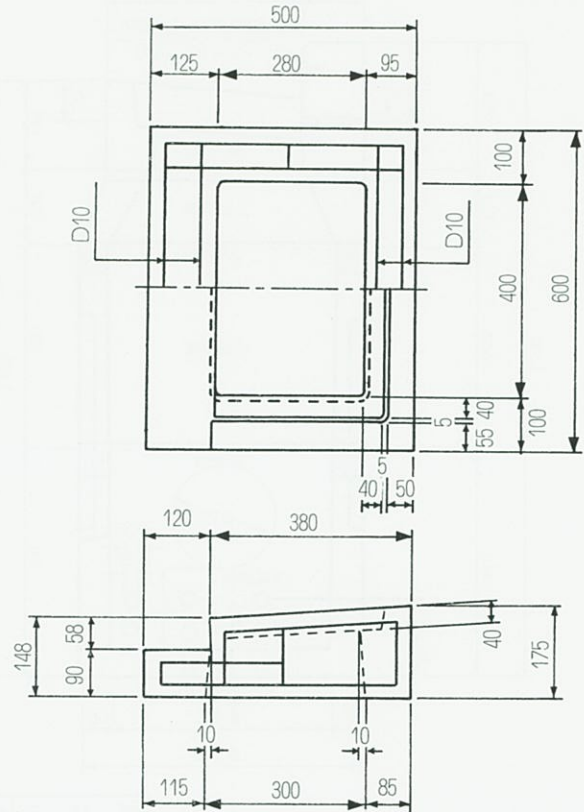

呼び名	参考重量(kg)
縁塊	58
上部側塊	49
中部側塊	73
下部側塊	84

上部側塊

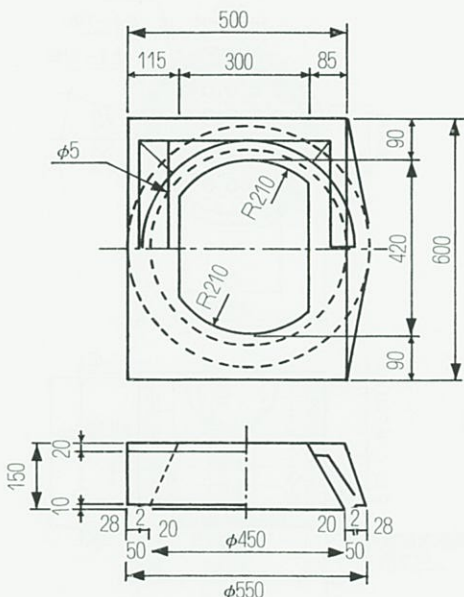

中部側塊

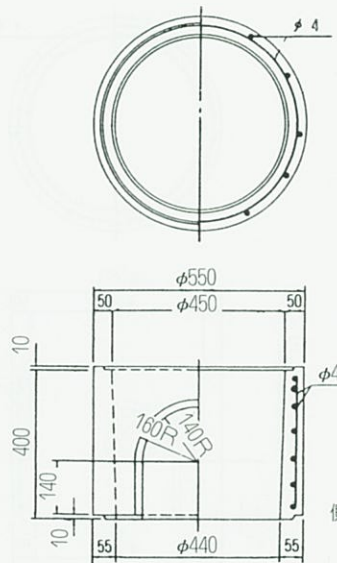

下部側塊

