

横浜市環境創造局型U型雨水枡

UM-24

UM-N 24 B

コンクリート基礎

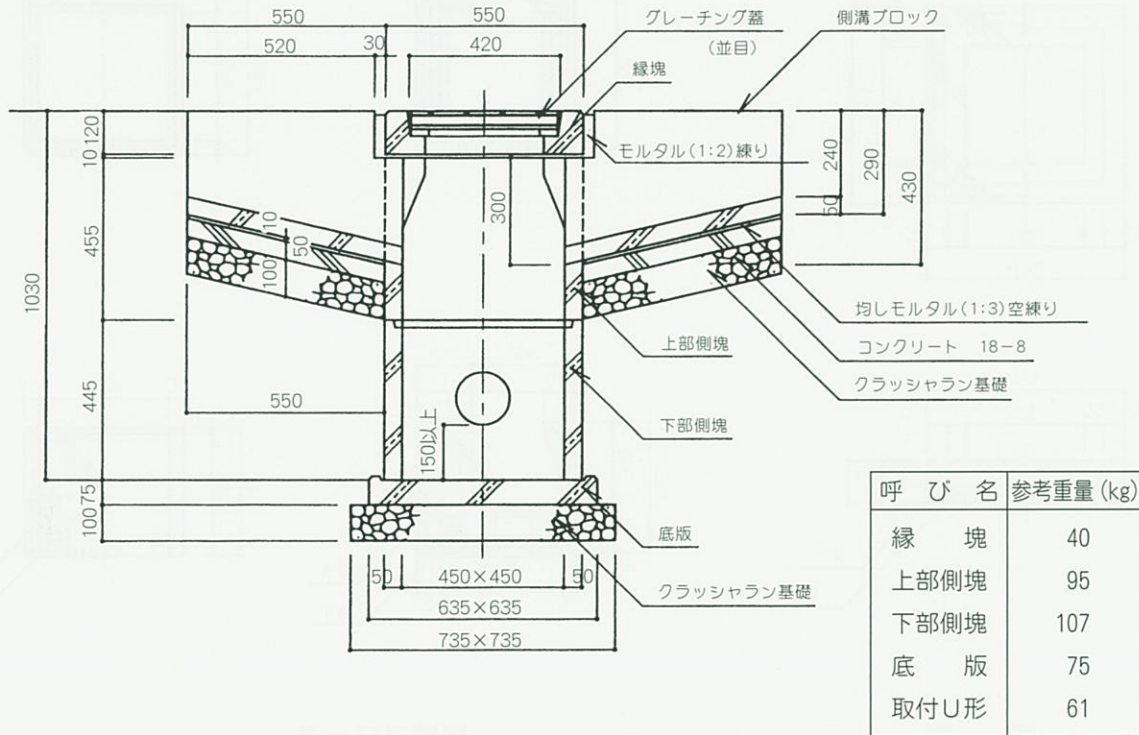

UM-N 24 A

砕石基礎

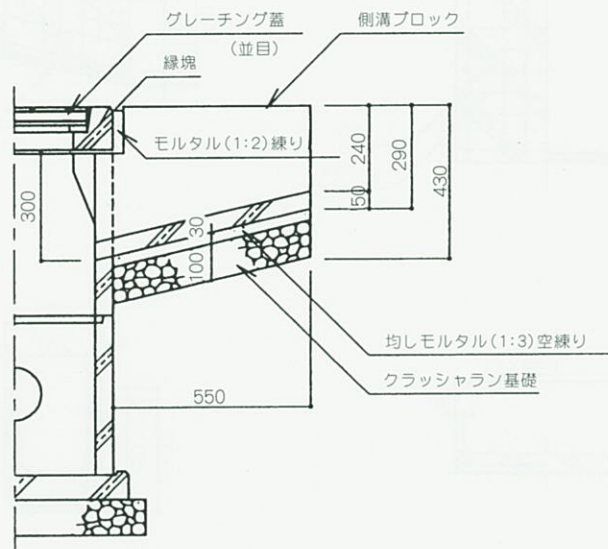

縁 塊

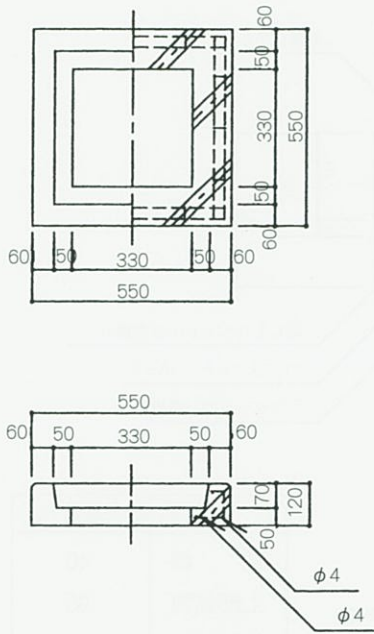

上部側塊

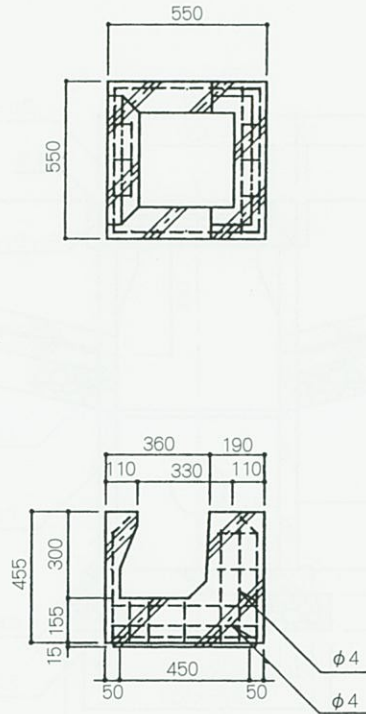

下部側塊

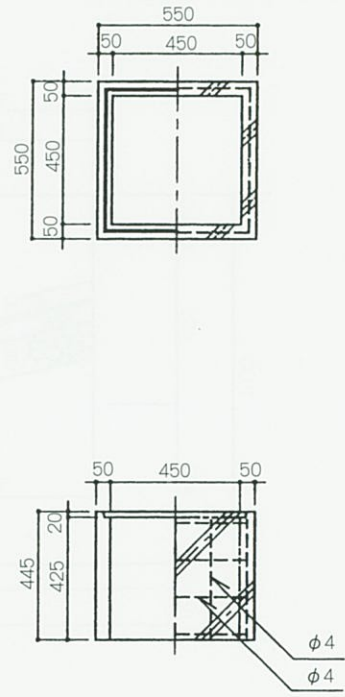

底 版

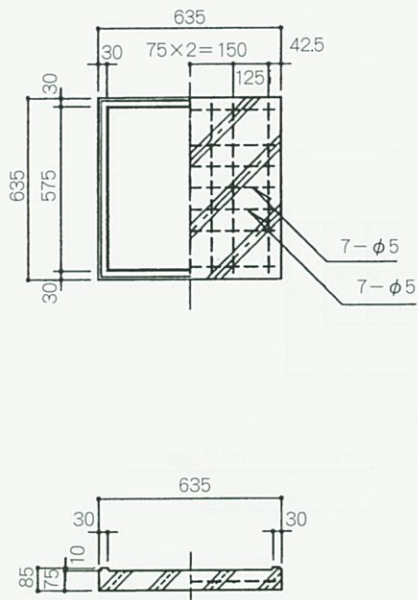

側溝ブロック

